

PRODOTTI / RICAMBI
PRODUCTS / SPARE PARTS
PRODUITS / PIECES DETACHEES
PRODUKTE / ERSATZTEILE
PRODUCTOS / REPUESTOS

TALENTO 2011

Esplosi

07-10-2011

Inizio produzione 02/05/2011
start production 02/05/2011

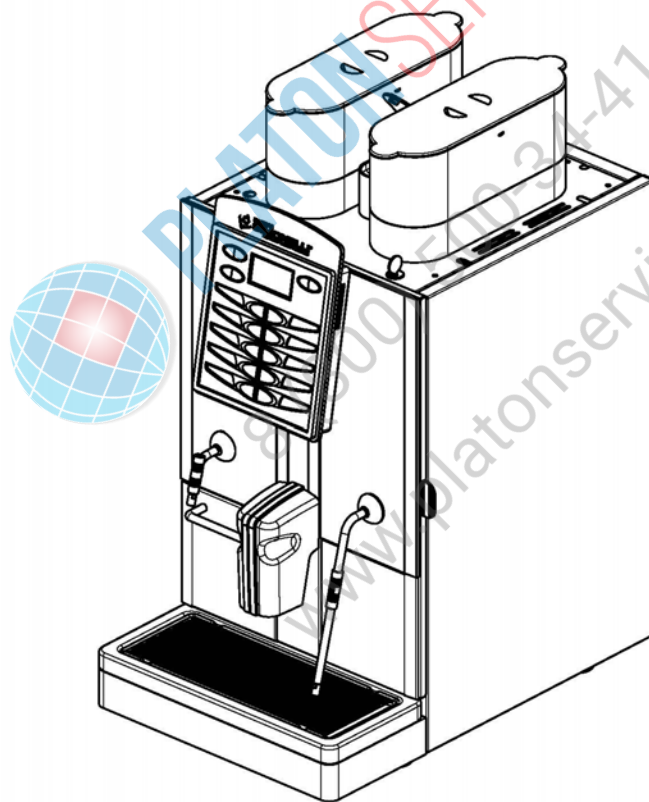

 nuova
SIMONELLI®

I N D I C E

- » TAV 01 - COMPONENTI GRUPPO CARENA
- » TAV 02 - COMPONENTI PORTA SERVIZI FRONTALE
- » TAV 03 - COMPONENTI GRUPPO TELAIO
- » TAV 04 - COMPONENTI GRUPPO POMPA
- » TAV 05 - COMPONENTI IDRAULICI STANDARD
- » TAV 06 - COMPONENTI IDRAULICI KIT ECONOMIZZATORE
- » TAV 07 - COMPONENTI GRUPPO EROGAZIONE
- » TAV 08 - COMPONENTI GRUPPO CALDAIE
- » TAV 09 - COMPONENTI ELETTRICI ED ELETTRONICI

» LEGENDA :

I CODICI SCRITTI IN GRASSETTO SI RIFERISCONO AI COMPONENTI IMPIEGATI ATTUALMENTE.

I CODICI IMPIEGATI PRIMA SONO SCRITTI IN CORSIVO CON INDICATA A FIANCO LA DATA DI FINE VALIDITA'.



ESEMPIO:

03001531 - 01/09/2007
03001531

 nuova
SIMONELLI®

COMPONENTI GRUPPO CARENA

BODYWORK COMPONENTS

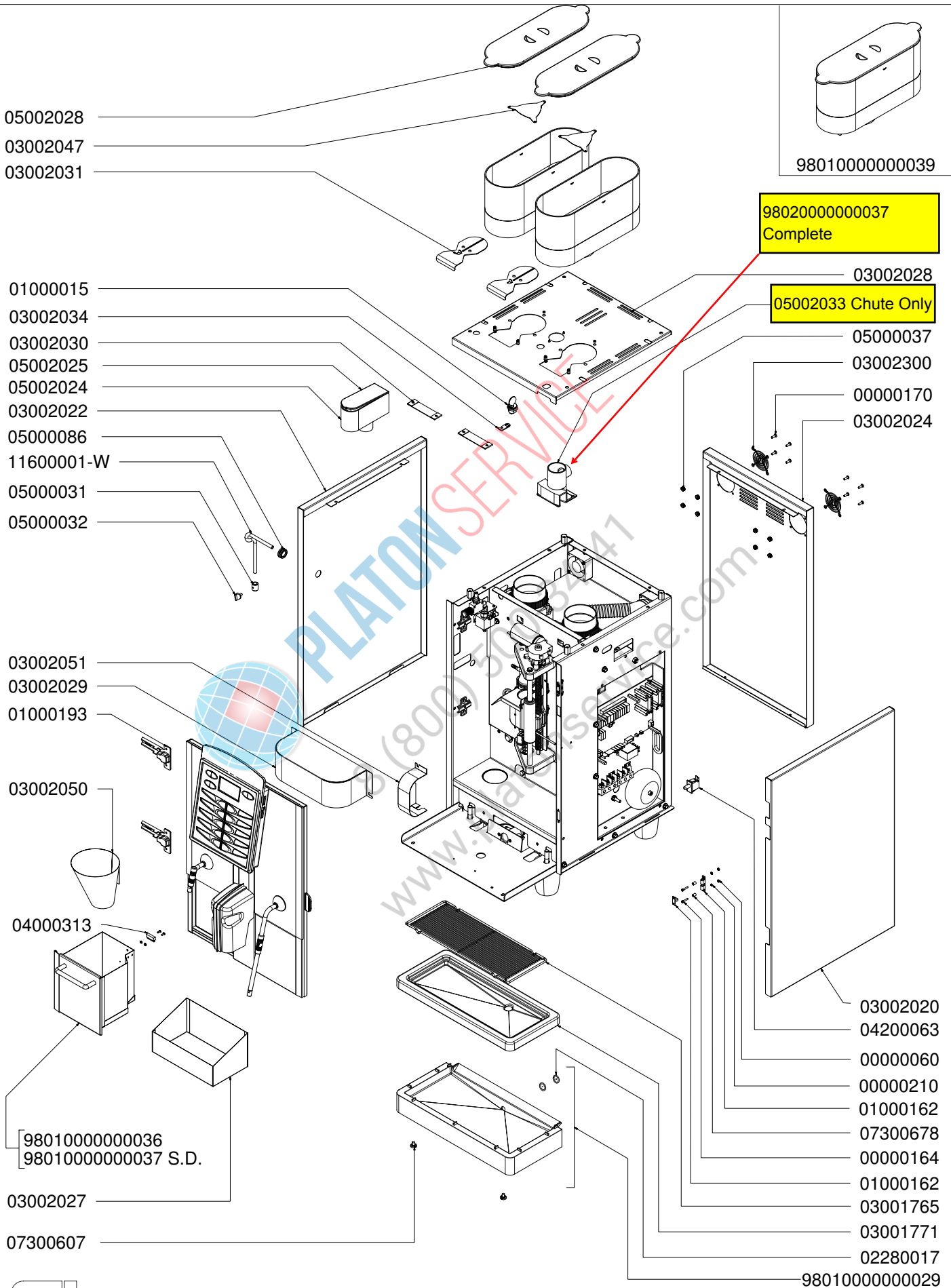

PORTA SERVIZI FRONTALE

SERVICES DOOR PANEL

T
A
L
E
N
T
O

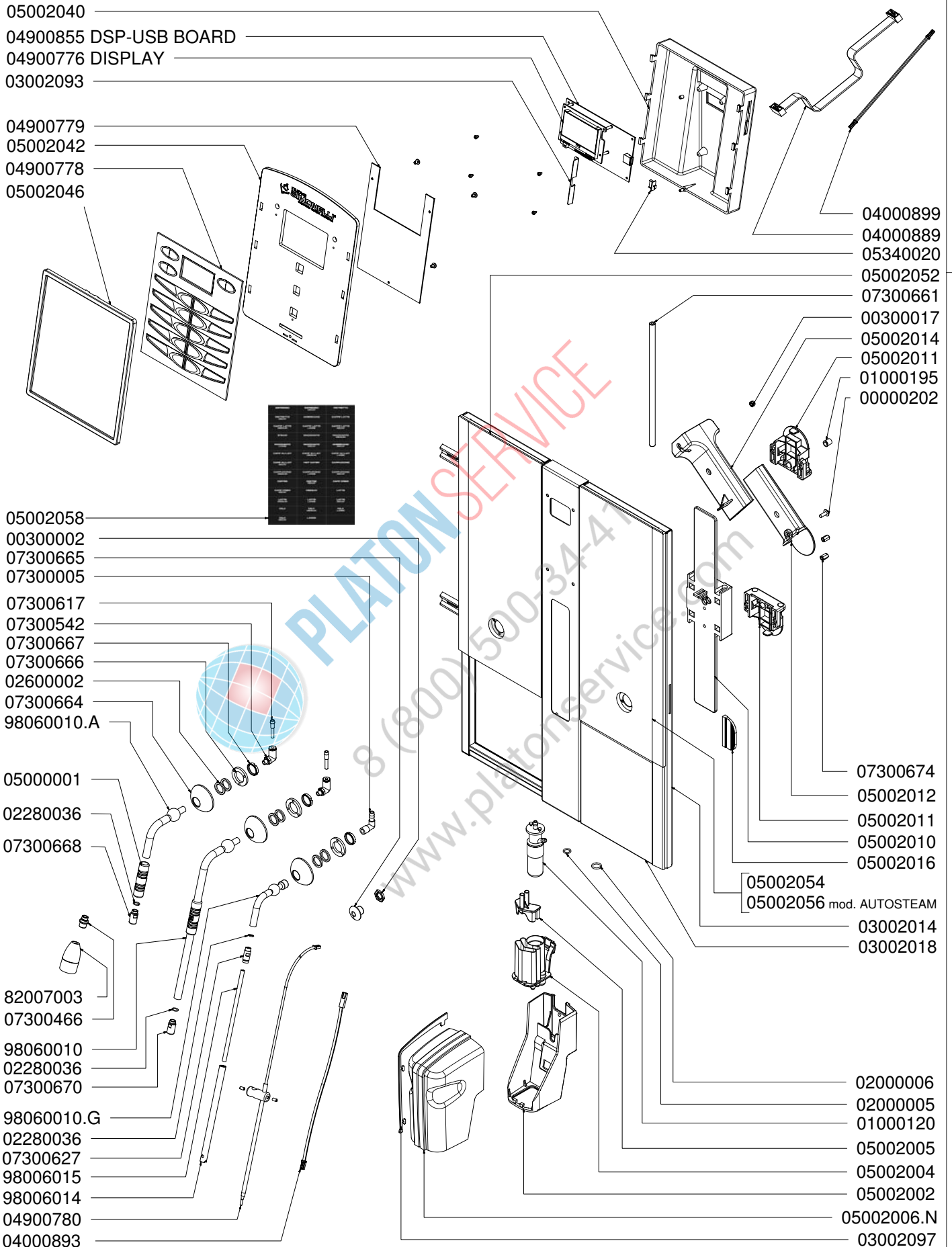

nuova simonelli

TAV 02

COMPONENTI GRUPPO TELAIO

FRAME COMPONENTS

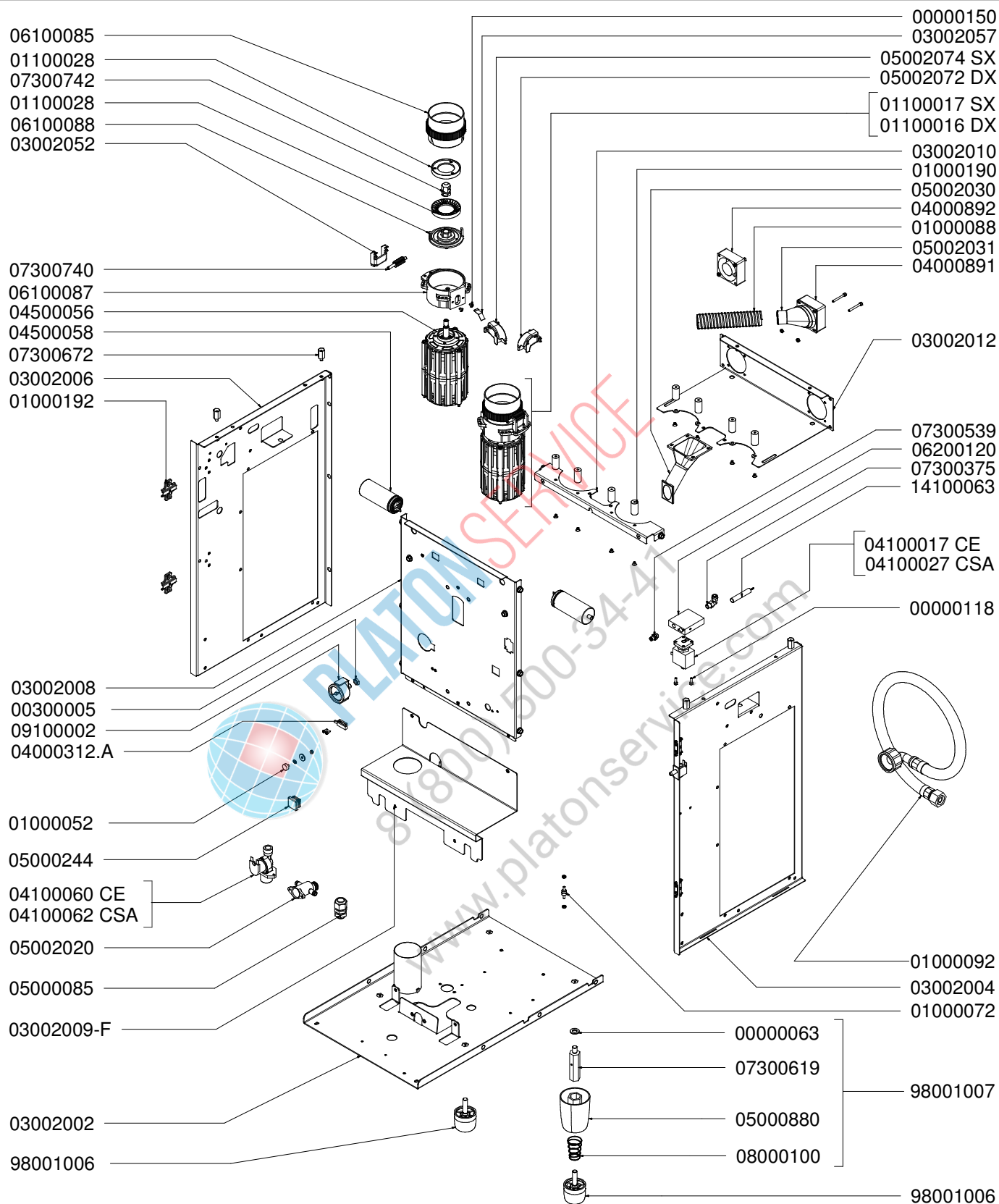

CODICE/CODE	DESCRIZIONE	DESCRIPTION
00000070	Fascetta per tubo scarico diretto fondi	Sgt clip 50/70 9 W2
00000133	Fascetta per tubo scarico diretto acqua	Stainless steel girdle WD12 16-25 C7 W2
01000080	Tubo D=60 per scarico fondi	Spiral pipe for dregs drain D=60
01000087	Tubo scarico acqua 18x24.4	Drain pipe 18x24.4

COMPONENTI GRUPPO POMPA PUMP GROUP COMPONENTS

VERSIONE STANDARD STANDARD VERSION

VERSIONE CON MISCELATORE ECONOMIZER VERSION

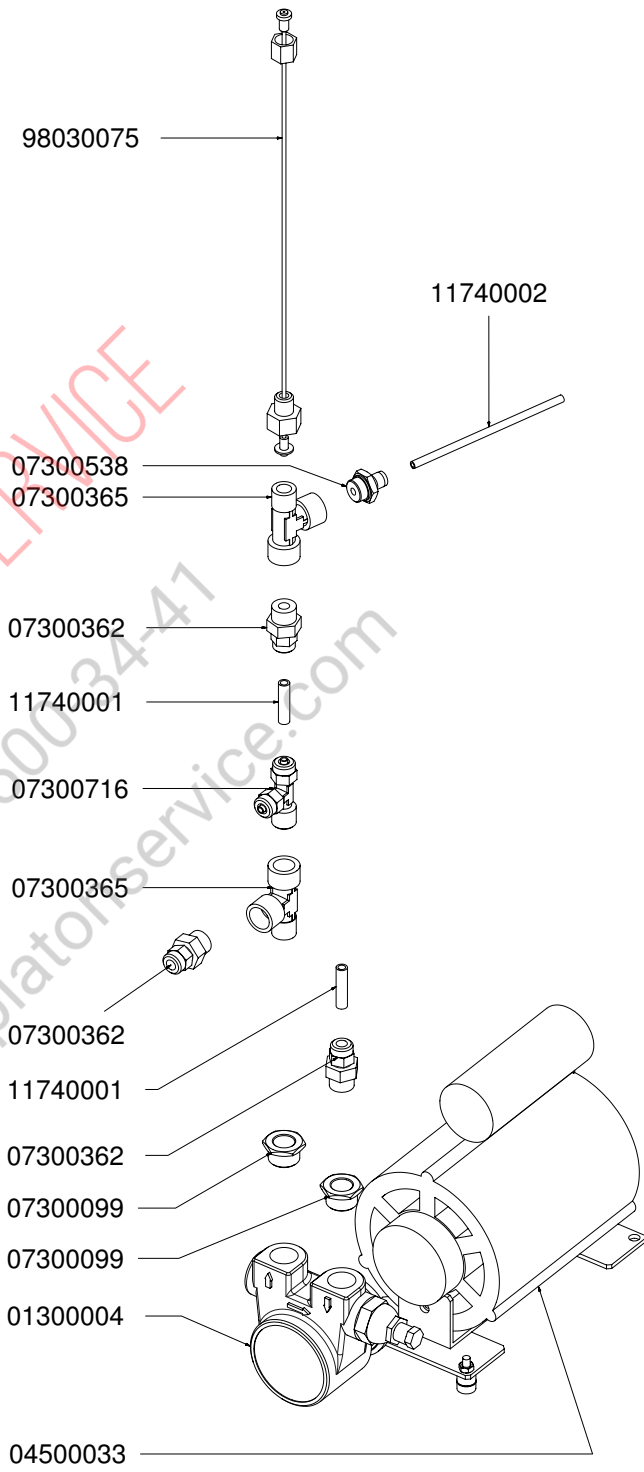
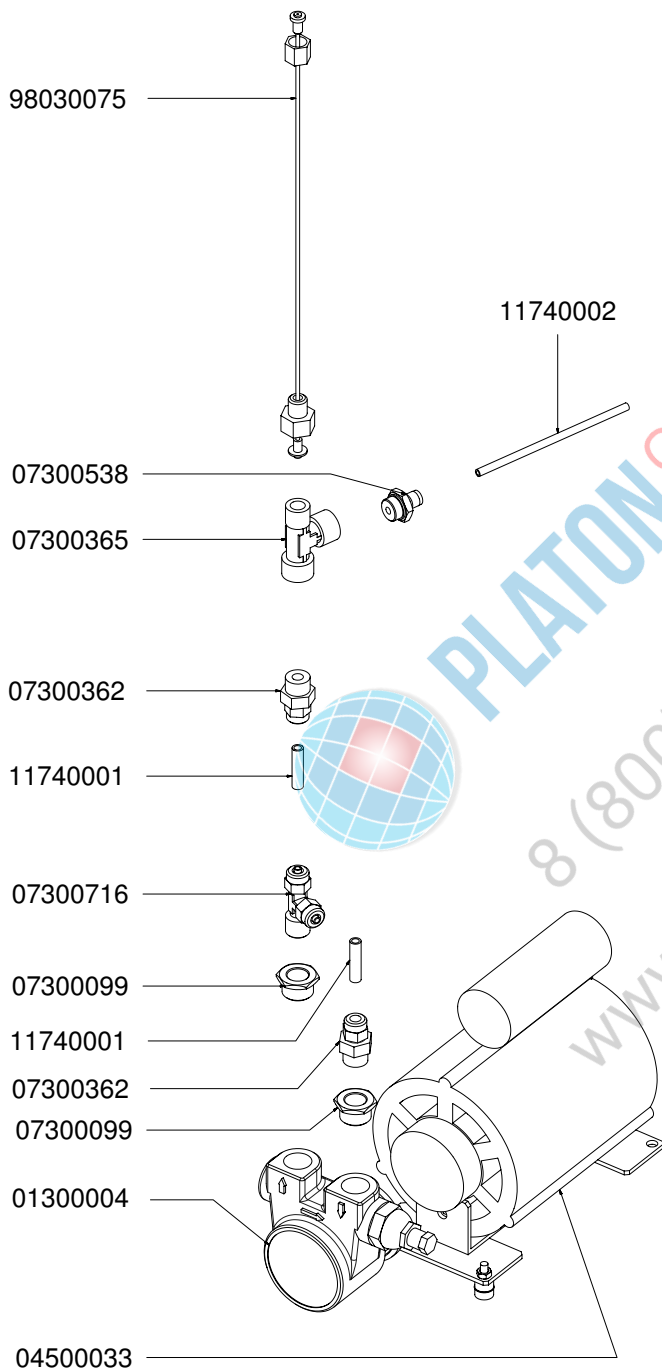

COMPONENTI IDRAULICI - VERSIONE STANDARD

HYDRAULIC COMPONENTS - STANDARD VERSION

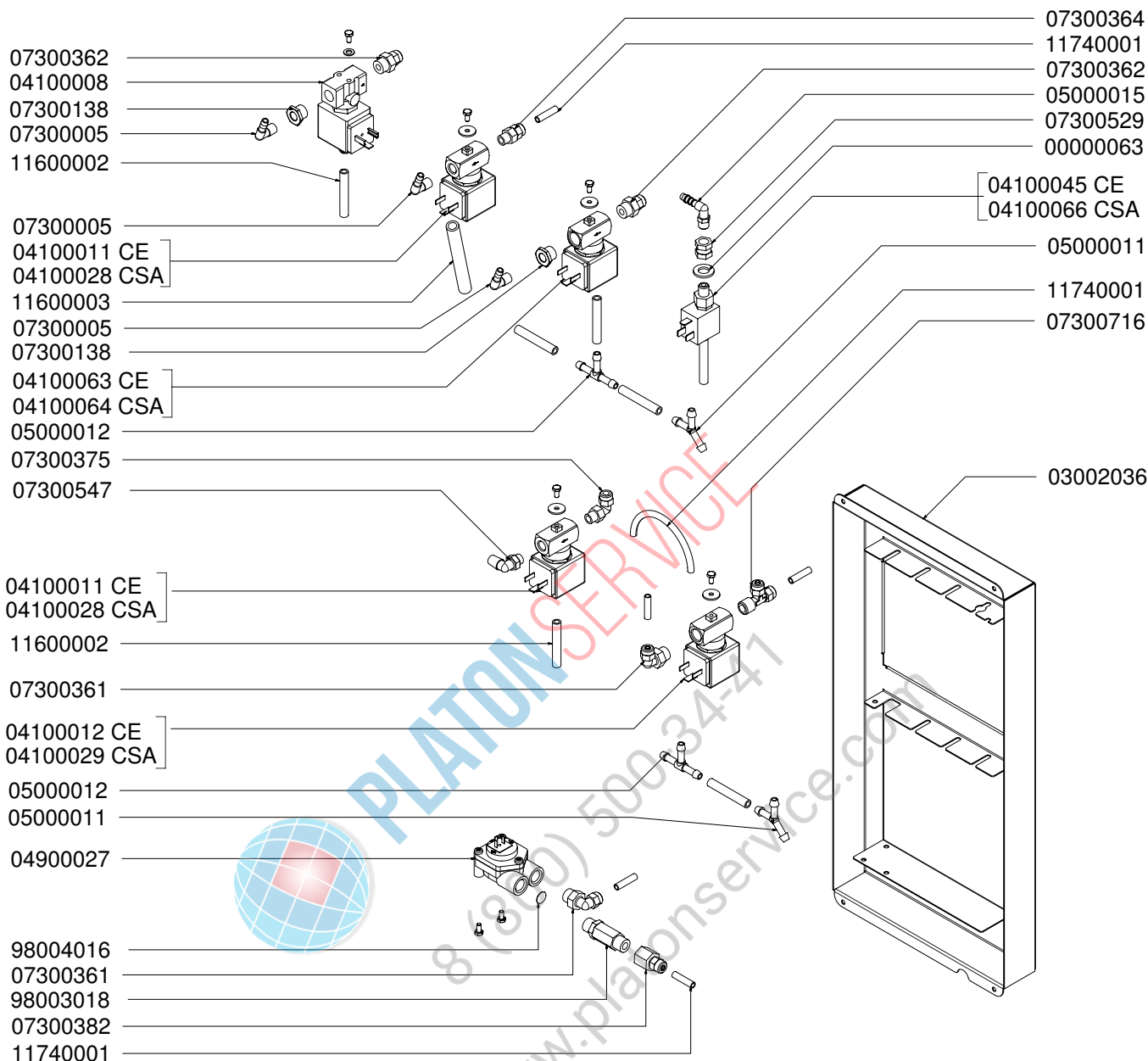

98210000000180000

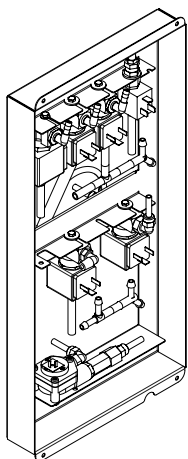

98210000000140000

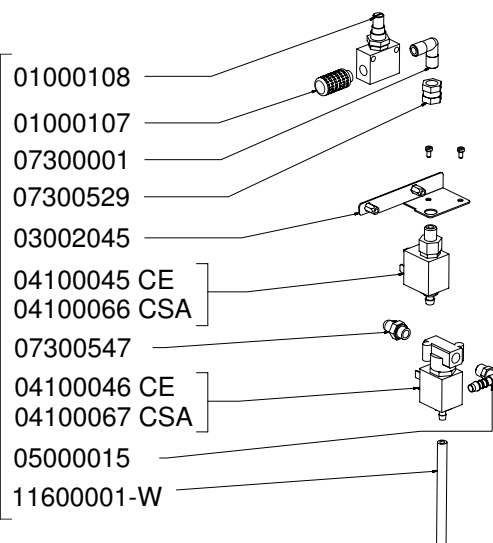

nuova simonelli

COMPONENTI IDRAULICI - VERSIONE CON MISCELATORE

HYDRAULIC COMPONENTS - ECONOMIZER VERSION

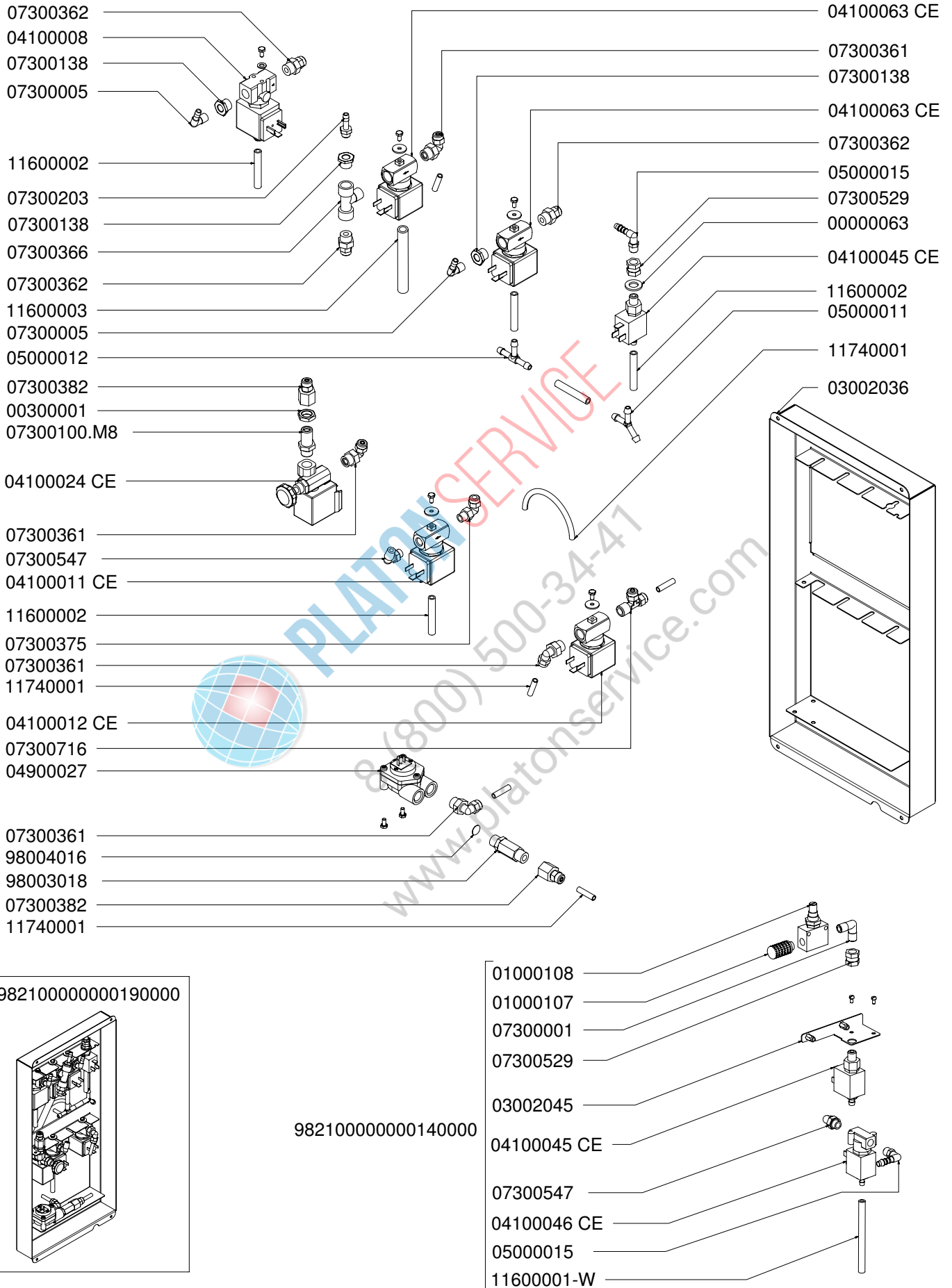

COMPONENTI GRUPPO EROGAZIONE

DELIVERY GROUP COMPONENTS

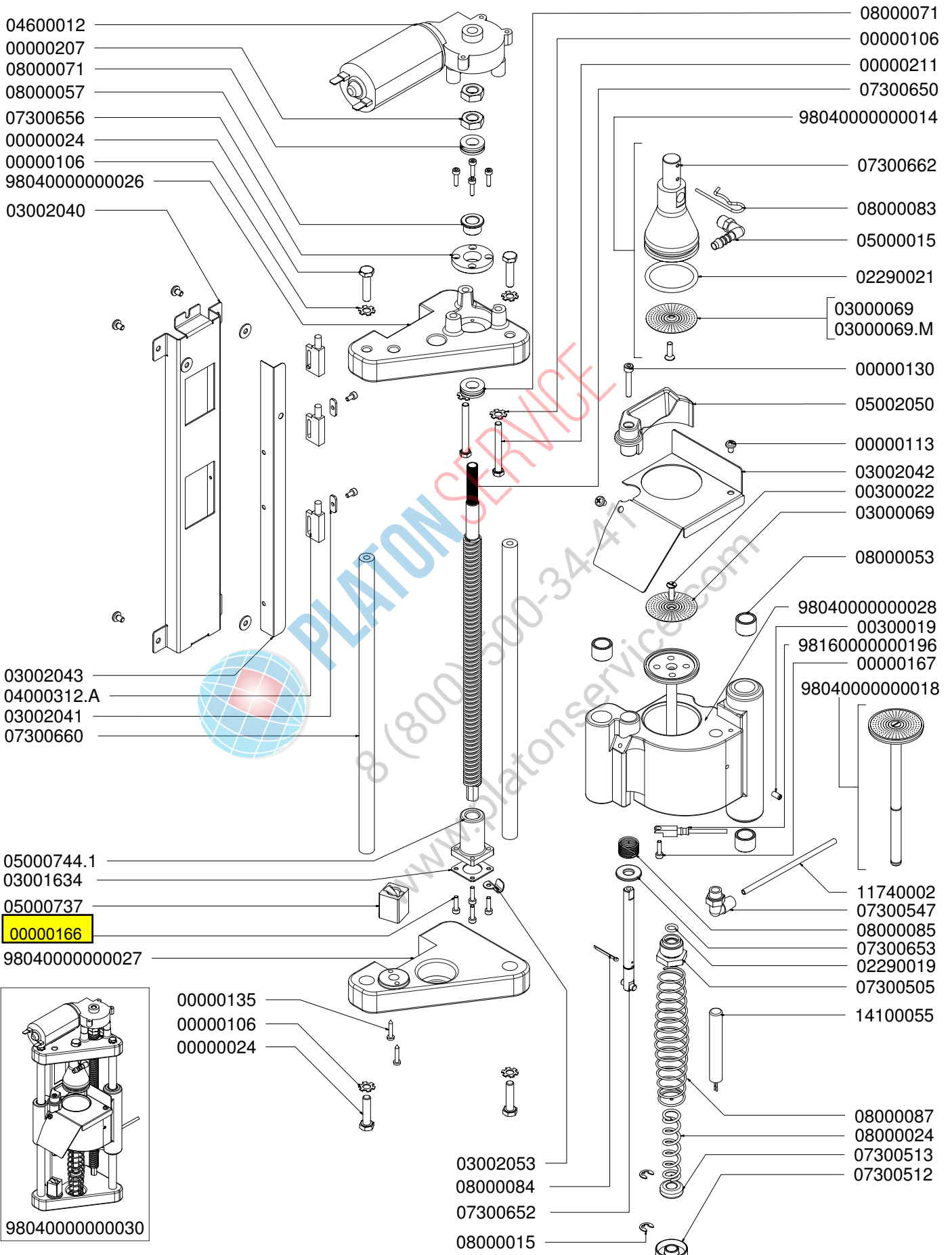

COMPONENTI GRUPPO CALDAIE

BOILERS COMPONENTS

T
A
L
E
N
T
O

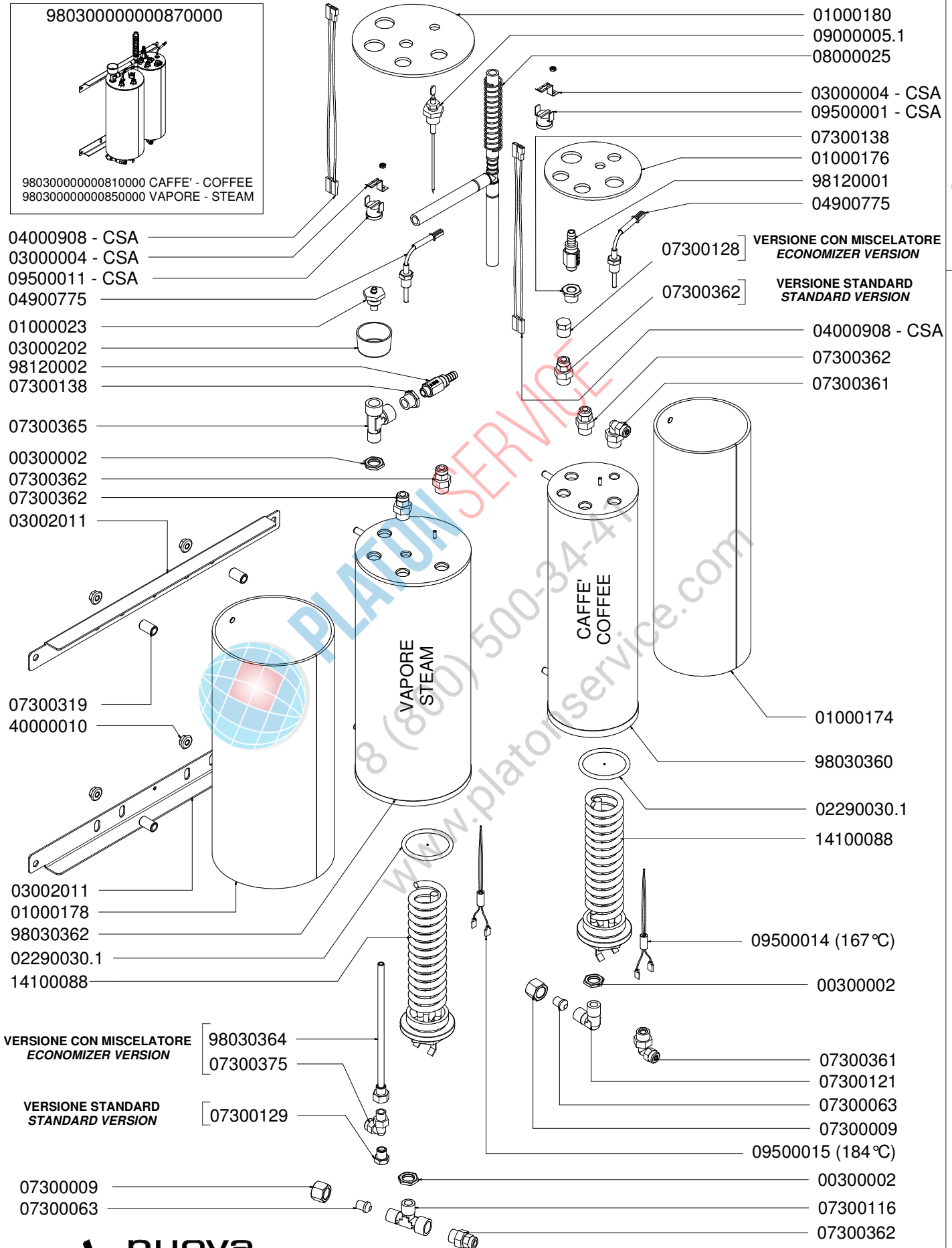
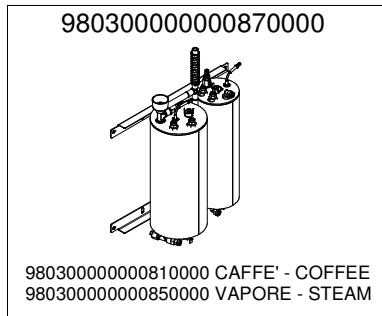

COMPONENTI ELETTRICI ELECTRICAL COMPONENTS

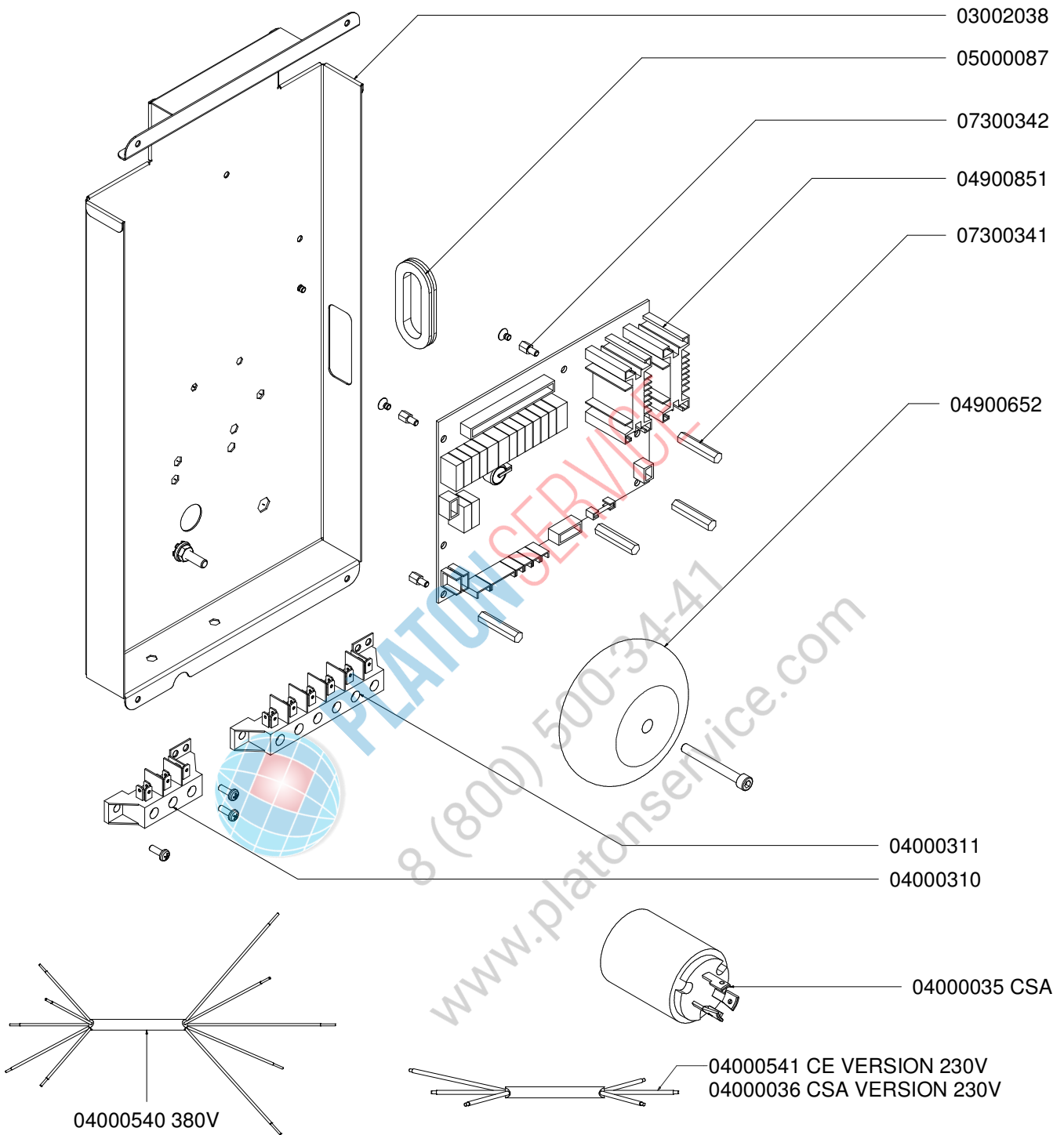

CODICE	FINE VALIDITA' VALIDITY END	DESCRIZIONE	DESCRIPTION
04000890		Impianto elettrico	Electric wiring
04000889		Cavo pulsantiera-centralina	Push botton panel-junction box cable
04000888		Cablaggio motoriduttore	Electric motor cable
04000907		Cavo di terra L=130cm	Earthing cable L=130cm
04000887		Cablaggio sensori campane	Bells sensors cable

CODICE	DESCRIZIONE	DESCRIPTION	DATA FINE VALIDITA'	T A L E N T O
00000024	VITE AQ M6x25 TE	HEX-HEAD SCREW M6x25		
00000060	DADO AQ M3 MEDIO ZINCATO	NUT M3 MEDIUM GALVANISED NUT		
00000063	RONDELLA AQ D 10X21X2 ZN	WASHER AQ D 10X21X2 ZN		
00000070	FASCETTA SGT 50/70 9 W4	SGT CLIP 50/70 9 W2		
00000106	RONDELLA ZIGRINATA DIAM 6	MILLED WASHER DIAM. 6		
00000113	VITE INOX M4x6 TC T.CR. 7985	SS CROSSHEAD CAP SCREW M4x6		
00000118	VITE INOX M4x12 TCEI 5931	SS HEX SOCKET CAP SCREW M4x12		
00000130	VITE INOX M4x25 TCEI UNI 5931	SS HEX SOCKET CAP SCREW M4x25		
00000133	FASCETTA INOX WD12 16-25 C7 W2	STAINLESS STEEL GIRDLE WD12 16-25 C7 W2		
00000135	VITE AUTOF 2,9x15 TCTC ZIN.	GALV. SLOTTED CAP SELF-TAPPING SCREW 2,9x15		
00000150	VITE INOX M4x6 TBEI ISO 7380	STAINLESS STEEL M4x6 TBEI ISO 7380		
00000164	VITE INOX M3x16 TCEI ISO 4762	STAINLESS STEEL SCREW M3x16 TCEI ISO 4762		
00000165	VITE INOX M3x8 TCEI ISO 4762	STAINLESS STEEL SCREW M3x8 TCEI ISO 4762		
00000167	VITE INOX M3x12 TCEI ISO 4762	STAINLESS STEEL SCREW M3x12 TCEI ISO 4762		
00000170	VITE INOX M4x12 TBEI ISO 7380	SS BUTTON HEAD HEX SOCKET SCREW M4x12 ISO 7380		
00000202	VITE AUTOF 4,1x12,9 TLARGA TCR NERA	SELF-TAPPING CROSS HEAD WIDE BLACK SCREW 4.1x12.9		
00000207	DADO AQ M10x1,25 BASSO ZINC.	LOW, ZINC AQ NUT M10x1.25		
00000210	RONDELLA AQ M3 ZIGRINATA UNI 8842/A	STAINLESS STEEL KNURLED WASHER D3		
00000211	VITE INOX M5x45 TE UNI 5739	SS HEX SCREW 5x45 UNI5739		
00300001	DADO OT 1/4 GAS SPESS.5 CH18 *AGG. 22.07.96	BRASS NUT 1/4 GAS SPESSOR 5		
00300002	DADO OT 1/4 SPESS.3 CH18 AGG. 22.07.96	BRASS NUT 1/4 SPESSOR 3		
00300005	DADO OT 1/8 GAS AGG.22.07.96 SPESS.4 CH13	BRASS NUT 1/8 GAS SPESSOR 4		
00300017	DADO AUTOBLOC INOX M4 ALTO DIN982	SELF-LOCKING STAINLESS STEEL NUT M4 HIGH DIN 982		
00300019	GRANO INOX M4X6 UNI 5923	STAINLESS STEEL DOWEL M4X8 5923		
00300022	VITE INOX M4x14 TSP TC DIN963	INOX SCREW M4X14 TSP TC DIN963		
01000015	SERRATURA INVOLUCRO COMANDI	CONTROL BOARD DOOR LOCK		
01000023	VALVOLINA SFIATO	ANTI VACUUM VALVE		
01000052	CALAMITA RPV 14	MAGNET RPV 14		
01000072	ANTIVIBRANTE AD 10x10 M4 MM	ANTI-VIBRATING AD 10X10 M4 MM		
01000080	TUBO SCARICO FONDI SPIRAL.D.60	SPIRAL PIPES FOR DREGS DRAIN PIPE D. 60		
01000087	TUBO SCARICO 18x24,4	DRAINING TUBE 18x24,4		
01000088	TUBO VENTILAZIONE SPIRAL. D.30	SPIRAL VENT PIPE D. 30 COILS 30 m		
01000092	TUBO CARICO ACQUA 1,5mt EPDM 3/8F OTT. - 3/4F90°	3/8F-3/4F90° WATER CHARGE PIPE 1,5mt		
01000107	SILENZIATORE 1/8 491	SILENCER 1/8 491		
01000108	RUBINETTO MRF 1/8 F-F 604	TAP 1/8 F-F		
01000120	CAPPUCCINATORE	NSF MILK FOAMER FOR MICROBAR		
01000162	SCROCCHETTO COMPL. MICROBAR	MICROBAR LOCK COMPLETE BCT-40		
01000174	ISOLANTE CALDAIA CAFFE' D.90 270x294	COFFEE BOILER INSULATOR D.90 270x294		
01000176	ISOLANTE D.90 CALDAIA CAFFE'	COFFEE BOILER INSULATOR D.90		
01000178	ISOLANTE CALDAIA VAPORE D.115 270x369	COFFEE BOILER INSULATOR D.115 270x369		
01000180	ISOLANTE D.115 CALDAIA VAPORE	STEAM BOILER INSULATOR D.115		
01000190	ANTIVIBRANTE 15x30 M4 FF	VIBRATION DAMPER 15x30 M4 FF		
01000192	BASE CERNIERA PORTA "TALENTO" (SALICE)	HINGE SUPPORT BASE WILLOW "TALENTO"		
01000193	CERNIERA PORTA "TALENTO" (SALICE)	HINGE SUPPORT WILLOW "TALENTO"		
01000195	PRESSORE A MOLLA D.8 TALENTO	SPRING SPHERE		
01100016	MACINACAFFE' COMPLETO REG. DX TALENTO N.S.	GRINDER FOR TALENTO RIGHT		
01100017	MACINACAFFE' COMPLETO REG. SX TALENTO N.S.	GRINDER FOR TALENTO LEFT		
01100028	COPIA MACINE D.63,5 MACININO TALENTO N.S.	PAIR GRINDERS D.63.5 FOR TALENTO GRINDER		
01300004	POMPANTE VOLUMETRICO 50 lt/h	VOLUMETRIC PUMP 50 lt/h		
02000005	OR SUP. CAPPUC. MICROBAR SILICONE ROSSO	UPPER GASKET FOR MICROBAR CAPPUCCINO MAKER		
02000006	OR INF. CAPPUC. MICROBAR	LOWER GASKET FOR MICROBAR CAPPUCCINO MAKER		
02280017	GUARN. OR R3062/AN12 D21 EP851	ORING GASKET R3062/AN12 D21 EP851		
02280036	GUARN. OR x BECCO LANCIA VAP. D.10 EPDM70	GASKET OR x STEAM WAND NOZZLE		
02290019	GUARNIZIONE OR R6 DF801 VITON	GASKET O-RING LOWER PISTON OR R6 DF801		
02290021	GUARN. OR 140/4137 D.41.5 SILICONE ROSSO Sh70	GASKET O-RING 140/4137 D.41.5 SILICON RED Sh70		
02290030.1	GUARN.OR 147 D.50 NBR NERO	GASKET OR 147 D.50 NBR BLACK		
02600002	GUARNIZ. TEFLON RESISTENZA	TEFLON GASKET FOR HEAT, ELEMEN		
03000004	STAFFA SINGOLA x TERMOSTATO	STEEL HOLDER FASTOM FOR THERMOSTAT		
03000069	DOCCIA INOX D.40 x M4 T.SVP AGG.08.01.99	STAINLESS SPOUT D.40		
03000069.M	DOCCIA INOX D.40 x M4 T.SVP MICROFORI 0.25mm	SS SHOWER D. 40 X M4 COUNTERSUNK WITH MICRO-OPENINGS 0.3 mm		
03000202	VASCHETTA RACC.CONDENSEA MASTERAGG. 07.06.97	CONDENSATION TRAY MASTER		
03001634	PIASTRINA FISSAGGIO CHIOCCIOLA VITE GRUPPO MICROBAR	FASTENING PLATE FOR MICROBAR GROUP SCREW VOLUTE		
03001765	RETINA PIANO LAVORO 1 GR.	WORKTOP NET 1 GR.		
03001771	PIATTO RACCOGLIACQUA 1 GR	DRIP TRAY		
03002002	BASE TELAIO TALENTO	FRAME BASE TALENTO		
03002004	FIANCO TELAIO DX TALENTO	RIGHT SIDE FRAME TALENTO		
03002006	FIANCO TELAIO SX TALENTO	LEFT SIDE FRAME TALENTO		
03002008	LAMIERA SUPP. GRUPPO TALENTO	GROUP SUPPORT PANEL TALENTO		
03002009.F	LAMIERA SUPP.CASSETTO FONDI TALENTO	DREGS TRAY SUPPORT PANEL WITH DRAIN HOLE D. TALENTO		
03002010	LAMIERA SUPP.MACININI TALENTO	GRINDER SUPPORT PANEL TALENTO		
03002011	STAFFA SUPP. CALDAIE TALENTO	BOILER SUPPORT BRACKET TALENTO		
03002012	LAMIERA SUPP.VENTOLE TALENTO	FAN SUPPORT PANEL TALENTO		
03002014	PORTA FRONTALE RIVETTATA TALENTO	FRONT HATCH RIVETED TALENTO		
03002018	CHIUSURA PORTA FRONTALE DX TALENTO	RH FRONT HATCH CLOSURE TALENTO		
03002020	FIANCO INOX DX TALENTO	SS RIGHT HAND SIDE PANEL TALENTO		
03002022	FIANCO INOX SX TALENTO	SS LEFT HAND SIDE PANEL TALENTO		
03002024	RETRO INOX TALENTO	STAINLESS STEEL BACK TALENTO		
03002027	VASCHETTA RACCOGLIIPOLVERE TALENTO	DUST TRAY TALENTO		
03002028	PIANO CHIUSURA SUPERIORE TALENTO	TOP COVER PANEL TALENTO		
03002029	CARTER COPRIMOTORE TALENTO	MOTOR POURING GROUP CASE - TALENTO		
03002030	LAMIERA FISSAGGIO GHIGLIOTTINA CAMPANA TALENTO	BELL GUILLOTINE FASTENING PANEL TALENTO		
03002031	GHIGLIOTTINA CAMPANA TALENTO	BELL GUILLOTINE TALENTO		
03002034	PIASTRINA SERRATURA TALENTO	LOCK PLATE TALENTO		
03002036	SUPPORTO ELETTROV. TALENTO	SOLENOID VALVE SUPPORT TALENTO		
03002038	SUPPORTO CENTRALINA TALENTO	CONTROL BOARD SUPPORT TALENTO		
03002040	LAMIERINO RETRO GRUPPO TALENTO	GROUP REAR LAMINATION TALENTO		
03002041	LAMIERINO BLOCCA SENSORE TALENTO	SENSOR LOCK LAMINATION TALENTO		
03002042	LAMIERA GR.TEFLONATA TALENTO	TEFLON-COATED GROUP PANEL TALENTO		
03002043	LAMIERINO COPRI SENSORI GRUPPOTALENTO	GROUP SENSOR COVER LAMINATION TALENTO		
03002045	SUPPORTO EV ARIA + EV PULIZIA TALENTO	CLEANING VALVE SUPPORT TALENTO		
03002047	SICUREZZA CAMPANA TALENTO INOX	SS BELL SAFETY TALENTO		
03002050	IMBUTO SCARICO DIRETTO TALENTO	DIRECT WASTE FUNNEL TALENTO		
03002051	PROTEZIONE CONNETTORE GRUPPO TALENTO	PROTECTION POURING GROUP TALENTO CONNETTOR		
03002052	SUPPORTO VITE S.F. MACININO TALENTO	GRINDER ADJUSTMENT SCREW SUPPORT		
03002053	PIASTRINA FISSAGGIO CAVI	CABLE FASTENING PLATE FOR TALENTO		
03002058	USCITA INOX CAFFE' MACININO TALENTO	GRINDER CHUTE TALENTO		
03002059	MOLLA LAMIERINO USCITA CAFFE' MACININO TALENTO	GRINDER CHUTE FLAP TALENTO		
03002093	LAMIERINO CHIUSURA SMART CARD TALENTO	TOUCHPAD PANEL HOLLE COVER		
03002097	LAMIERA FISS. BECCO + PRESA	SS SUPPORT PURING SPOUT COVER		
03002300	GRIGLIA METALLICA x VENTILAT. 60x60 GM60	METAL GRILLE FOR FAN GM60		
04000035	SPINA 30A 250V USA L630P	PLUG 30A 250V L630P		
04000036	CAVO ELETTRICO 3x12AWG SJO ETL300V 90°C	ELECTRICAL CORD 3x12 AWG SJO ETL		
04000310	MORSETTIERA A VITE FV110 220V.	SCREW TERMINAL FV110 220 V		
04000311	MORSETTIERA A VITE FV122 380V TRIFASE+NEUTRO 6 POLI	SCREW TERMINAL 380 V		
04000312.A	SENSORE MAGNETICO L=400	MAGNETIC SENSOR L400		
04000313	UNITA' MAGNETICA M 305 AA	MAGNETIC UNIT M 305 AA		
04000540	CAVO ELETTR. FROR 5x2,5 2mt 450/750V	POWER SUPPLY CABLE FROR 5x2,5 2mt		
04000541	CAVO ELETTR. FROR 3x4 2mt 450/750V	POWER SUPPLY CABLE FROR 3x4 2mt		
04000887	CABLAGGIO SENSORI CAMPANE + RACCORDO DECA TALENTO	BELLS SENSOR WIRING TALENTO		
04000888	CABLAGGIO MOTORIDUTT. TALENTO	GEAR MOTOR WIRING TALENTO		
04000889	CAVETTO CONNES. SCHEDA TAST. -SCHEDA I/O "TALENTO"	WIRE TO CONNECT "TALENTO" TOUCHPAD-CONTROL BOARD		

CODICE	DESCRIZIONE	DESCRIPTION	DATA FINE VALIDITA'	T A L E N T O
04000890	IMPIANTO ELETTRICO TALENTO	WIRING TALENTO		
04000891	VENTOLA 24V 0,08A DC 60x60x25	24 V DC 60x60x25 FAN 0.08A		
04000892	VENTOLA 24V 0,15A DC 60x60x25	24 V DC 60x60x25 FAN 0.15A		
04000893	CAVO PROLUNGA AUTOSTEAM TALENTO M-F	EXTENSION CABLE AUTOSTEAM TALENTO		
04000899	CAVO CONNES. SCHEDA TAST.- SCHEDA ILLUMINAZ. TALENTO 2VIE	BOARD-PANEL LIGHTING CONNECTING CABLE - TALENTO		
04000907	CAVO TERRA L130 CON OCCHIELLO D6 TALENTO	EARTH WIRE L130 1 SLOTS D6		
04000908	CAVO TERMOSTATO CALDAIA TALENTO VERSIONE CSA	BOILER THERMOSTAT/CABLE - TALENTO CSA VERSION		
04100008	E.V. NC 3VIE 1/4-1/4 SCAR. 1/8220V 50Hz-240V 60Hz RUBY F3 UL	NC 3-WAY SOLENOID 1/4-1/4 1/8 OUTLET		
04100011	E.V. NC 3VIE 1/8-1/8 SCAR. 1/8220-230V 50/60Hz VITON F1.3 CE	SOLENOID VALVE		
04100012	E.V. NC 2VIE 1/4-1/4 220-230V 50/60Hz VITON F1.5 CE	EV 2W 1/4 1/4 220-230V 50/60Hz VITON F1.5 CE		
04100017	E.V. NC 3VIE BASETTA SCAR. 1/8220-230V 50/60Hz RUBY F1.5 CE	EV 3W DOWNL 1/8 220-230V 50/60Hz RUBY F1.5 CE		
04100024	E.V. NC 2VIE 1/4 REGOLAT. 90° 230V 50/60Hz F.3 + MANOP. EPDM CE	2 WAYS EV WITH REGULATOR		
04100027	E.V. NC 3VIE BASETTA SCAR. 1/8208-240V 60Hz RUBY F1.3 UL	EV 3W DRAIN 1/8 208-240V 60Hz RUBY D1,3 UL		
04100028	E.V. NC 3VIE 1/8-1/8 SCAR. 1/8208-240V 60Hz RUBY F1.3 UL	E.V. EROGAZ. MASTER APPROV UL		
04100029	E.V. NC 2VIE 1/4-1/4 208-240V 60Hz VITON F1.5 UL	E.V. 2VIE AL 220/240 50/60 UL		
04100045	E.V. NC 2VIE 1/8M-PORTAGOMMA 230V 50/60Hz VITON F1.7 CE	2-WAY SOLENOID 1/8 M HOSE SUPPORT		
04100046	E.V. NC 3VIE 1/8-1/8 PORTAG. 230V 50/60Hz VITON F1.5 CE	ELECTR. 3-WAY 1/8" F1.5 230V 50/60Hz HOSE CLAMP OUTLET		
04100060	E.V. NC 2VIE 3/4-JG 6 DIRITTA REGOL+FILTR F.2,5 230V 50/60Hz	2-WAY SOLENOID VALVE 3/4-JG 6 230V 50/60Hz		
04100062	E.V. NC 2VIE 3/4-JG 6 DIRITTA REGOL+FILTR F.2,5 208/240V60HzUL	2-WAY SOLENOID VALVE 3/4-JG 6 230V 60Hz UL		
04100063	E.V. NC 3VIE 1/4-1/4 SCAR. 1/8230V 50Hz VITON F2.5 CE	3-WAY SOLENOID 1/4-1/4 1/8 OUTLET F.2,5		
04100064	E.V. NC 3VIE 1/4-1/4 SCAR. 1/8208-240V 60Hz VITON F2.5 UL	3-WAY SOLENOID 1/4-1/4 1/8 OUTLET F.2,5 UL		
04100066	E.V. NC 2VIE 1/8M-PORTAGOMMA 208/240V 60Hz VITON F1.7 UL	2-WAY SOLENOID 1/8M-HOSE SUPPORT VITON F1.7 UL		
04100067	E.V. NC 3VIE 1/8-1/8 PORTAG.UL 208/240V 60Hz VITON F1.5 V0	NC 3-WAY SOLENOID 1/8-1/8 HOSE SUPPORT 208-240V 60Hz VITON F1		
04200063	MICROSWITCH PORTA	DOOR MICROSWITCH		
04500033	MOTORE EL. MASTER/PREMIER 2001230V 50/60Hz 120W	PUMP MOTOR MASTER/PREMIER 2001 230V 50/60Hz		
04500056	MOTORE ELETTRICO 230V 50/60Hz 245W MACININO TALENTO N.S.	230V 50/60Hz 245W ELECTRIC MOTOR FOR GRINDER - TALENTO N.S.		
04500058	CONDENSATORE PER MOTORE MACININO TALENTO N.S.	CONDENSER FOR GRINDER MOTOR - TALENTO N.S.		
04600012	MOTORIDUTTORE 24V TALENTO	GEAR MOTOR 24V GMGP 404.157 DN.43		
04900027	DOSATORE VOLUMETRICO OTT.	FLOWMETER		
04900652	TRASF. COMPL.MICROBAR 230V/18V 150VA 50/60Hz FUSE750mAT	COMPLETE TRANSFORMER 230V-18 150VA 50/60Hz FUSE750m		
04900775	SONDA TEMPERATURA 150° NTC ATT.1/8 INOX 4x20	TEMPERATURE PROBE 150° NTC ATT.1/8 SS 4x20 Lwire=500 mm. A		
04900776	DISPLAY GRAFICO G64128X11 + BASETTA TALENTO	DISPLAY TALENTO		
04900778	PULSANTIERA LEGENDABILE "TALENTO"	TOUCH PAD WITH KEY TALENTO		
04900779	SCHEDA ILLUMINAZIONE PANNELLO LED SMD TALENTO	PANEL LIGHTING CARD TALENTO		
04900780	SONDA PT1000 X LANCIA VAPORE "TURBO CREAM" D06 + SUPPORTO	PROBE PT1000 X STEAM WAND "TURBO CREAM" D06		
04900851	SCHEDA CPU I/O POTENZA TALENTO 2011 Rel. 4.16	POWER CARD TALENTO 2011		
04900855	SCHEDA CPU TASTIERA + DISPLAY GRAFICO TALENTO 2011 Rel. 4.16	DISPLAY BOARD TALENTO 2011		
05000001	GOMMINO PROTEZIONE LANCIA D.10	STEAM ARM RUBBER GRIP		
05000011	RACCORDO PORTATUBO YS 6	YS 6 HOSE FASTENING		
05000012	RACCORDO PORTATUBO TS 6	TS 6 HOSE FASTENING		
05000015	RACCORDO PORTATUBO WES 6R 1/8	WES 6R 1/8 HOSE FASTENING		
05000031	ANELLO REGOLAZ. CAPPUCCIATORE	MILK-FOAMER REGULATION RING		
05000032	POMELLO FILETTATO	THREADED KNOB		
05000037	GHIERA FILETTATA PER PANNELLI M4 BIANCO	THREADED RING NUT FOR PANELS M4 WHITE		
05000085	PRESSACAVO TEC-S M20 D.7-14 CON DADO P-CT M20 Es24	CABLE GLAND TECH-S M20 D.7-14+ NUT P-CT M20		
05000086	PASSACAVO A MEMBRANA BIANCO	MEMBRANE CABLE DUCT		
05000087	PASSACAVO PVC OVALE NERO OV7	BLACK PVC GROMMET OVAL		
05000244	TAPPO COPRIFORO QUADRATO 25x25 NERO STQ 25x25	22 x 19 RECTANGULAR BLACK CAP TO COVER HOLE		
05000737	BOCCOLA MOV. ESPULSIONE MICROBAR	MICROBAR UNIT EJECTION BUSHING		
05000744.1	CHIOCCIOLA VITE MOVIMENTO T.N.NYLON MICROBAR	MICROBAR VOLUME MOVEMENT SCREW		
05000848	RACCORDO RAPIDO PASSAPARETE D4	D4 BULKHEAD SNAP-ON JOINT		
05000880	PROLUNGA PIEDE ALTO 2005 D.66 H=80 mm.	TALL FOOT EXTENSION D.66 H=80 MM.		
05002002	ATTACCO EROG. CAFFE' TALENTO PA6+FV30	COFFEE POURING FASTENING TALENTO PA6+FV30		
05002004	BECCO EROG. INTERNO TALENTO POM	INTERNAL POURING SPOUT TALENTO POM		
05002005	TAPPO BECCO EROG TALENTO POM	POURING SPOUT TALENTO POM		
05002006.N	COVER BECCO EROG. TALENTO NERO	POURING SPOUT COVER TALENTO BLACK		
05002010	SLITTA BECCO TALENTO PA6+FV30	SPOUT SLIDE TALENTO PA6+FV30		
05002011	SUPPORTO A C TALENTO PA6+FV30	A C SUPPORT TALENTO PA6+FV30		
05002012	TELESCOPICO A TALENTO PP	TELESCOPIC A PP		
05002014	TELESCOPICO B TALENTO PP	TELESCOPIC B PP		
05002016	MANIGLIA PORTA TALENTO	DOOR HANDLE TALENTO		
05002020	ATTACCO SCARICO VASCHETTA TALENTO	TRAY WASTE FASTENING TALENTO		
05002024	CONVOGLIATORE DETERGENTE TALENTO	DETERGENT CONVEYOR TALENTO		
05002025	COPERCHIO CONVOGLIATORE TALENTO	CONVEYOR LID TALENTO		
05002028	COPERCHIO CAMPANA TALENTO	BELL LID TALENTO		
05002030	SCIVOLO CAFFE' TALENTO	COFFEE CHUTE TALENTO		
05002031	SCIVOLO CAFFE' TALENTO TAGLIATO	COFFEE CHUTE TALENTO (CUT)		
05002033	CHIUSURA SCIVOLO x MACININO N.S. TALENTO	GRINDER UPPER CONVEYER TALENTO		
05002040	SUPPORTO PULSANTIERA TALENTO	TOUCH PAD SUPPORT TALENTO		
05002042	LUMINOSA METACRILATO TALENTO	LIT METHACRYLATE TALENTO		
05002046	CORNICE PULSANTIERA TALENTO	TOUCH PAD CORNICE TALENTO		
05002050	PALETTA ESPULSIONE TALENTO	EJECTION PALETTE TALENTO		
05002052	PANNELLO VETRO SX PORTA SPESS.6 TALENTO	LH GLASS DOOR PANEL TH. 6 TALENTO		
05002054	PANNELLO VETRO DX PORTA SPESS.6 TALENTO	RH GLASS DOOR PANEL TH. 6 TALENTO		
05002056	PANNELLO VETRO DX - AUTOSTEM TALENTO	RH GLASS DOOR PANEL TH. 6 TALENTO AUTOSTEAM		
05002058	ETICHETTE LEGENDABILI PULS. TALENTO N.38 BEVANDE+7 NEUTRI	KEY LEGEND DECALS - TALENTO		
05340020	PROTEZIONE x PRESA USB	USB PLUG PROTECTION		
06100085	PORTAMACINE SUPERIORE FINITO MACININO TALENTO	UPPER GRINDER HOLDER - TALENTO GRINDER		
06100087	TAZZA CONVOGLIATORE FINITO MACININO TALENTO	LOWER CONVOGYER - TALENTO GRINDER		
06100088	PORTAMACINA INFERIORE MACININO TALENTO	LOWER GRINDER HOLDER - TALENTO GRINDER		
06200120	BLOCCETTO PORTA EV. CAFFE' TALENTO	BRASS SUPPORT FOR SOLENOID VALVE		
07300001	RACCORDO L 1/8 M-M 459	L FITTING 1/8 M-M		
07300005	PORTAGOMMA ANG. 1/8 X 7 F1 4.8AGG. 18.06.96	ANGULAR HOSE CLAMP 1/8"		
07300009	DADO RACCORDO 1/4 GAS	NUT CONNECTION 1/4 GAS		
07300063	TERMINALE CHIUSO D 11	TERMINAL D 11 CLOSED		
07300099	RIDUZIONE 3/8 1/4 ES. 20 AGG. 29.05.96	VACUUM RELIEF VALVE ADAPTER		
07300100.M8	ATTACCO SCARICO 1/4 VAS. SCAR.CON OR + INT. M8	DOWNLOAD FASTENING 1/4 DOWNLOAD TRAY WITH OR		
07300116	RACCORDO T 1/4 M-M-F	JOINT T1/4 M-M-F 465		
07300121	RACCORDO L 1/4 M-M. CILIN 459 AGG. 18.02.97	CONNECTION L 1/4 M-M CYLIN. 459		
07300128	TAPPO 1/4 GAS AGG.31.01.89	CAP 1/4 GAS		
07300129	TAPPO 1/8 GAS	CAP 1/8 GAS		
07300138	RIDUZIONE 1/4"- 1/8" ES. 17 AGG. 29.05.96	REDUCTION 1/4"-1/8" ES. 17 ADD. 29.05.96		
07300203	PORTAGOMMA CIL. 7 1/8	CYLINDRICAL HOSE CLAMP 1/8		
07300319	BOCCOLA CAVALLOTTO FULCRO LEVAAGG. 23.11.95	LEVER FULCRUM SLOT BUSHING ADD. 23.11.95		
07300341	PERNO BLOCC. CENTRAL. VIP INOXNICHELATO L=35	CENTRAL LOCK VIP NICKEL PLATED L=35		
07300342	PERNO SUPPORTO CENTRAL. VIP NICHELATO	NICKEL PLATED CONTROL UNIT SUPPORT PIN		
07300361	RACCORDO L GIR 6 1/4 VITON346A	PIVOTING CONNECTION L 6 1/4 VITON346A		
07300362	RACCORDO DIR.M.C.6 1/4 340	STRAIGHT FITTING 1/4		
07300364	RACCORDO DIR. M. CON.6 1/8 CALZ. 340	STRAIGHT FITTING 1/8 SHEATH TYPE D.6		
07300365	RACCORDO T 1/4 M-F-F	T FITTING 1/4 FFM		
07300366	RACCORDO T 1/4 F-M-F	CONNECTION T 1/4 F-M-F 462		
07300375	RACCORDO L GIR 6 1/8 VITON 346	L FITTING 1/8 VITON 346A		
07300382	RACCORDO DIR. F 1/4 - CALZAM.	CONNECTION DIR. F 1/4 ACTUATOR		
07300466	RACCORDO FILET. INOX x LANCIA VAPORE MAC/PROGRAM	STEAM WAND SS THREADED CONNECTION PROGRAM/MAC		
07300505	BOCCOLA ALBERO PISTONE SCARICO	MICROBAR DRAIN PISTON SHAFT BUSHING		
07300512	PIATTELLO PORTAMOLLA INFERIORE GR. MICROBAR	MICROBAR GROUP LOWER SPRING WASHER		
07300513	PIATTELLO PORTAMOLLA SUPERIORE GR. MICROBAR	MICROBAR GROUP UPPER SPRING WASHER		
07300529	MANICOTTO FILETTATO 1/8 450	THREADED SLEEVE 1/8		
07300538	RACCORDO RAPIDO 1/4 DIRITTO D4	QUICK COUPLING 1/4 STRAIGHT D4RACCORDO RAPIDO 1/4 DIRITTO D4		
07300539	RACCORDO RAPIDO 1/8 DIRITTO D4	QUICK COUPLING 1/8 STRAIGHT D4		
07300542	RACCORDO RAPIDO M6 L GIR. D4	L FITTING QUICK COUPLING M6 L SWIVEL D4		

CODICE	DESCRIZIONE	DESCRIPTION	DATA FINE VALIDITA'	T A L E N T O
07300547	RACCORDO RAPIDO 1/8 L GIR. D4	1/8 L GIR. D4 SNAP-ON COUPLING		
07300607	PERNO FISSAGGIO CARENE M6-L.2 NICHELATO APPIA	FIXING HINGE M6 L.2		
07300617	PORTAGOMMA INNESTABILE D4 OTT FORO 3mm	BRASS HOSE CLAMP D4		
07300619	INSERTO PROLUNGA PIEDE ALTO ES 20 L=70 + M10	INSERTION EXTENSION TALL FOOT ES 20 L=70 M10		
07300627	ATTACCO INOX D.10 AUTOSTEAM M-M 8.65x0.75	AUTOSTEAM FITTING M-M 8.65X0.75		
07300650	VITE MOVIMENTO GR. "TALENTO"	GROUP MOVEMENT SCREW TALENTO		
07300652	ALBERO PALETTA TALENTO	EJECTION BLADE SHAFT TALENTO		
07300653	RONDELLA OT D.20x8.1xS.2	BRASS WASHER D.20x8.1xTh.2		
07300656	BOCCOLA FLANGIATA GR TALENTO	GR FLANGED BUSHING TALENTO		
07300660	COLONNA D.12 GR TALENTO	GR COLUMN D 12 TALENTO		
07300661	COLONNA D.8 GUIDA BECCO EROG. TALENTO	POURING SPOUT GUIDE COLUMN D. 8 TALENTO		
07300662	PISTONE EROG. SUP. TALENTO RESINA ACETALICA	TALENTO TOP POURING PISTON ACETALIC RESIN		
07300664	ATTACCO INOX LANCIA TALENTO	WAND SS FASTENING TALENTO		
07300665	COPRIFORO SONDA AUTOSTEAM	AUTOSTEAM PROBE HOLE COVER		
07300666	BASSETTA INOX ATTACCO LANCIA TALENTO	WAND FASTENING SS BASE TALENTO		
07300667	REGISTRO LANCIA TALENTO	WAND ADJUSTER - TALENTO		
07300668	BECCO ACQUA D.10 INOX	SS WATER NOZZLE D.10		
07300670	BECCO VAPORE D.10 INOX	SS STEAM NOZZLE D.10		
07300672	PROLUNGA FISSAGGIO SCALDATAZZE TALENTO	TALENTO CUP WARMER FASTENING EXTENSIONS		
07300674	PROLUNGA FISSAGGIO SUPPORTO BECCO EROGAZIONE	POURING SPOUT SUPPORT FASTENING EXTENSION		
07300678	DISTANZIALE D.6 H.8 FORO.3,5	SHIM D.6 H.8 HOLE 3.5		
07300716	RACCORDO T 1/4 M -CALZAM. D.6 -CALZAM. D.6	1/4 M T CONNECTION - D. 6 ACTUATOR		
07300740	VITE S.F. CONTROLLO MACINATURATALENTO	ADJUSTMENT SCREW - TALENTO GRINDER		
07300742	DADO BLOCCAMACINA INFERIORE MACININO TALENTO	LOWER GRINDER LOCKNUT - TALENTO GRINDER		
08000015	ANELLO SEEGER TIPO RS 5 INOX UNI 7434	SEEGER RING RS 5 STAINLESS STEEL		
08000024	MOLLA EROG. 15 X 2 X 61 8,5ST	UPPER PISTON SPRING		
08000025	MOLLA SCAR. 16,5X1,2X80 12 ST	LOWER PISTON SPRING		
08000053	BOCCOLA BZ 12X16X12	BZ 12X16X12 BUSHING		
08000057	BOCCOLA BZ 10x10 FLANGIATA	BZ 10x10 FLANGED BUSHING		
08000071	CUSCINETTO ASSIALE COMBINIBILE 10x19x6	MODULAR AXIAL BEARING 19x10x6		
08000083	COPIGLIA ELASTICA D.2 L.43 C70 ZINCATO	RETAINER CLIP D.2 L.43 C70 GALVANISED		
08000084	COPIGLIA D.2 L.20 INOX 304 UNI 1336 - DIN 49 - ISO 1234	RETAINER CLIP D.2 L.20 304 SS UNI 1336 - DIN 49 - ISO 1234		
08000085	MOLLA PALETTA ESPULSIONE GR.TALENTO	TALENTO GROUP SCOOP SPRING		
08000087	MOLLA PISTONE SCARICO L.120 GRUPPO TALENTO	LOWER PISTON LONG SPRING TALENTO		
08000100	MOLLA INTERNA PIEDE 2005	FOOT INNER SPRING 2005		
09000005.1	SONDA AUTOLIVELLO COMP. L=130 CON GOLA	WATER LEVEL SENSOR		
09100002	MANOMETRO SCALA 0-16 BAR 1/8 D.40	PRESSURE GAUGE SCALE 0-16 BAR D40 SS RING NUT STEEL BODY		
09500001	TERMOSTATO RIARMO AUTOM 98°C	98°C AUTO RESET THERMOSTAT		
09500011	TERMOSTATO R.AUTO 150°C FASTON 6,3 VERTICALI	150°C AUTO RESET THERMOSTAT		
09500014	TERMOPROTETTORE RESISTENZA G5 167°C 16A 250V UL	THERMO PROTECTOR		
09500015	TERMOPROTETTORE RESISTENZA G5 184°C 16A 250V UL	HEATING ELEMENT THERMAL PROTECTION G5 184°C 16A 250V UL		
11600001.W	TUBO SILICONE BIANCO4x7,5 60Sh(1mt=41gr) SEMITRASPARENTE	WHITE SILICON PIPE 4x7.5 60 ShSEMI-TRANSPARENT		
11600002	TUBO SILICONE 5x8 60Sh PEROX (1mt=37gr) TRASPARENTE	SILICONE TUBE 5x8		
11600003	TUBO SILICONE 8x12 70Sh PEROX (1mt=75gr) TRASPARENTE	SILICON TUBE 8X12 70SH PEROX TRANSPARENT		
11740001	TUBO TEFLON 6/4	TEFLON PIPE 4x6		
11740002	TUBO TEFLON 4/2,5 CALIBRATO TRASPARENTE	TEFLON PIPE 4/2.5 CALIBRATED TRANSPARENT		
14100055	RESISTENZA A CARTUCCIA HW10x65 100W 230V	CARTRIDGE HEATING ELEMENT HW10x65 100W 230V		
14100063	RESISTENZA A CARTUCCIA D10x55 18W 230V	CARTRIDGE HEAT. ELEMENT D10x5518W 230V		
14100088	RESISTENZA 1"1/4 230V 2600W INCOLOY-800 A MATASSA	HEATING ELEMENT 1"1/4 230V 2600W INCOLOY-800 A COIL APPIA C		
40000010	DADO AQ M6 CON RONDELLA SALDATA ZINCATO	NUT M6 WITH WELD ZINCKED WASHER		
82007003	ROMPIGETTO ACQUA CALDA D.23,5 CAFF. ITA./AURELIA F1/8"	HOT WATER DISPERSION NUT D.23.5		
98001006	PIEDE MACCHINA 06 BICOMPONENTE D.48 H=40	MACHINE FEET replace 98001001		
98001007	KIT PIEDI ALTI AURELIA (4 PZ)	KIT TALL FEET AURELIA (4 PCS.)		
98003018	VALVOLA RITEGNO 98 ES.16	VALVOLA RITEGNO 98 ES.16 RETAIN VALVE		
98004016	FILTRO INOX DIAM. 12	STAINLESS FILTER DIAM. 12		
98006015	TUBO TEFLON 4x6 INTERNO LANCIA VAPORE L=147 mm.	TEFLON TUBE 4X6 INSIDE STEAM WAND L=147 MM.		
98006014	TUBO LANCIA INOX VAPORE L=163 FORO 1 mm TURBOCREAM	SS STEAM TUBE L=163, HOLE 1 mm TURBOCREAM		
98010000000029	ASSIEME VASCHETTA RACCOGLI ACQUA TALENTO	DREGS DRAWER ASSEMBLY TALENTO		
98010000000036	CASSETTO RACCOGLIFONDI COMPL. TALENTO	DREGS DRAWER ASSEMBLY (DIRECT DRAIN) TALENTO		
98010000000037	CASSETTO RACCOGLIFONDI SCARICODIRETTO COMPL. TALENTO	COFFEE BELL ASSEMBLY TALENTO		
98010000000039	ASSIEME CAMPANA TALENTO	COFFEE BOILER ASSEMBLY D=90 L=270 TALENTO 2011		
980300000000810000	ASSIEME CALDAIA CAFFÈ TALENTO 2011	STEAM BOILER ASSEMBLY D=115 L=270 TALENTO 2011		
980300000000850000	ASSIEME CALDAIE VAPORE TALENTO 2011	BOILERS ASSEMBLY TALENTO 2011		
980300000000870000	ASSIEME CALDAIE TALENTO 2011	BOILERS ASSEMBLY TALENTO 2011		
98030075	TUBO CAPILLARE 1/8-1/4 0,9x2x400 MANOMETRO- POMPA	CAPILLARY TUBE 1/8-1/4 0,9X2X400 MANOM.-PUMP		
98030360	CALDAIA CAFFÈ D90 L=270 INOX "TALENTO"	TALENTO SS COFFEE BOILER D90 L=270		
98030362	CALDAIA VAPORE D115 L=270 INOX "TALENTO"	TALENTO SS STEAM BOILER D115 L=270		
98030364	TUBO L.160 CON RACC. 1/8 M-F MISCELATORE TALENTO	DRAFT PIPE WITH 1/8" M-F FITTING		
980400000000018	ASSIEME PISTONE INFER. TALENTO	BOTTOM POURING PISTON ASSEMBLY TALENTO		
980400000000026	PIASTRA SUP.GRUPPO TALENTO LAVORATA	GROUP COLUMN TOP PLATE TALENTO		
980400000000027	PIASTRA INF.GRUPPO TALENTO LAVORATA	GROUP COLUMN BOTTON PLATE TALENTO		
980400000000028	GRUPPO TALENTO LAVORATO	MACHINED GROUP TALENTO		
980400000000030	ASSIEME GRUPPO EROGAZIONE "TALENTO 2008"	POURING GROUP ASSEMBLY "TALENTO 2008"		
98060010	LANCIA VAPORE INOX D10 L=200 "TALENTO"	TALENTO SS STEAM WAND		
98060010.A	LANCIA VAPORE INOX AUTOSTEAM "TALENTO"	AUTOSTEAM AND HOT WATER SS STEAM WAND TALENTO		
98060010.G	LANCIA VAPORE INOX AUTOSTEAM ATTACCO 1/8 "TALENTO"	AUTOSTEAM 1/8" SS STEAM WAND TALENTO		
98120001	VALVOLA NEPLAX VITON 16BAR 1/8 - PORTAGOMMA	NEPLAX VITON 16BAR VALVE 1/8 HOSE CLAMP		
98120002	VALVOLA NEPLAX VITON 6 BAR 1/8 - PORTAGOMMA	NEPLAX VITON 6 BAR VALVE 1/8 - HOSE SUPPORT		
981600000000196	SONDA TEMPERATURA GRUPPO TALENTO	TEMPERATURE GROUP PROBE TALENTO		
982100000000140000	ASS.SUPPORTO E.V. ARIA + PULIZIA TALENTO	AIR+AUTOWASHING VALVES ASSEMBLY TALENTO CE		
982100000000180000	ASS.SUPPORTO E.V. + DOSATORE TALENTO 2011 S/MISCELAT.	E.V. GROUP ASSEMBLY TALENTO 2011 STANDARD VERSION		
982100000000190000	ASS.SUPPORTO E.V. + DOSATORE TALENTO 2011 C/MISCELAT.	E.V. GROUP ASSEMBLY TALENTO 2011 ECONOMIZER VERSION		